

612B13N012 = 13.2:1 AXLE

612B20N012 = 19.7:1 AXLE

Section 'B' – Main Case and Differential Assembly

Item	Part No	Qty	Description
A1	0150250	2	Drain/Level Plug
A2	CP1488	1	Breather
A3	612-0010	1	Main Case
A4	612-0731	1	Diff. Bearing Housing
A5	0081535	8	Cap Screw M10x35mm
A6	0081312P	2	Cap Screw M6x12mm
A7	915-2151	2	Bearing Adjuster Nut
A8	CP1224	1	Sealing Washer
B1	400-2200	1	M24 Nyloc Nut
B2	915-2190	1	Washer
B3	612-2180	1	Input Flange SAE1410
B4	400-0910	1	Seal Cover
B5	002-0070V	1	Oil Seal Viton
B6	002-0070V	1	Oil Seal Viton
B7	055CU024H	1	Taper Roller Bearing
B8A	400-1050	1	Collapsible Spacer (0.9 mm wall thickness)
B8	216-2890 A,B,C,D,E	1	Spacer (5.4 mm wall thickness)
B9	055C026U057	1	Taper Roller Bearing
B10*	916-9820	1	Crown Wheel & Pinion Set
B11	0540552H	2	Taper Roller Bearing
B12	057340A 057340B 057340C	As Req	Shim 0.002" Shim 0.003" Shim 0.010"
B13	057189A 057189B 057189C 057189F	As Req	Shim 0.002" Shim 0.005" Shim 0.010" Shim 0.012"

**Includes 916-2000 Pinion and 916-2010 Crown Wheel. Matched Lapped pair can only be supplied.
B8 and B13 replaces B8A*

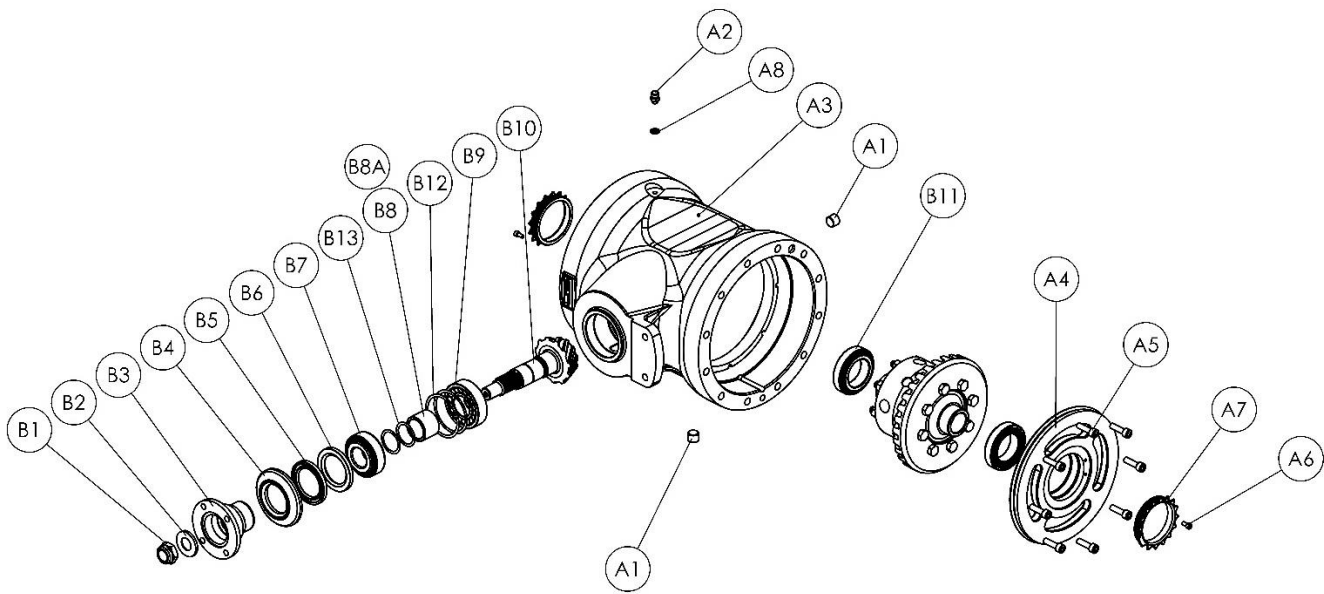

Item	Part No	Qty	Description
B14	612-9520	1	Differential Case
B15	915-2110	2	Thrust Washer
B16	915-2090	2	Differential Wheel
B17	915-2120	4	Thrust Washer
B18	915-2100	4	Differential Pinion
B19	915-2130	2	Spider
B10*	916-9820	1	Crown Wheel & Pinion Set (Pinion not shown)
B20	0041225HT	8	M12 Bolt
B21	007-0360	8	M12 Nyloc Nut

*Includes 916-2000 Pinion and 916-2010 Crown Wheel. Matched Lapped pair can only be supplied.

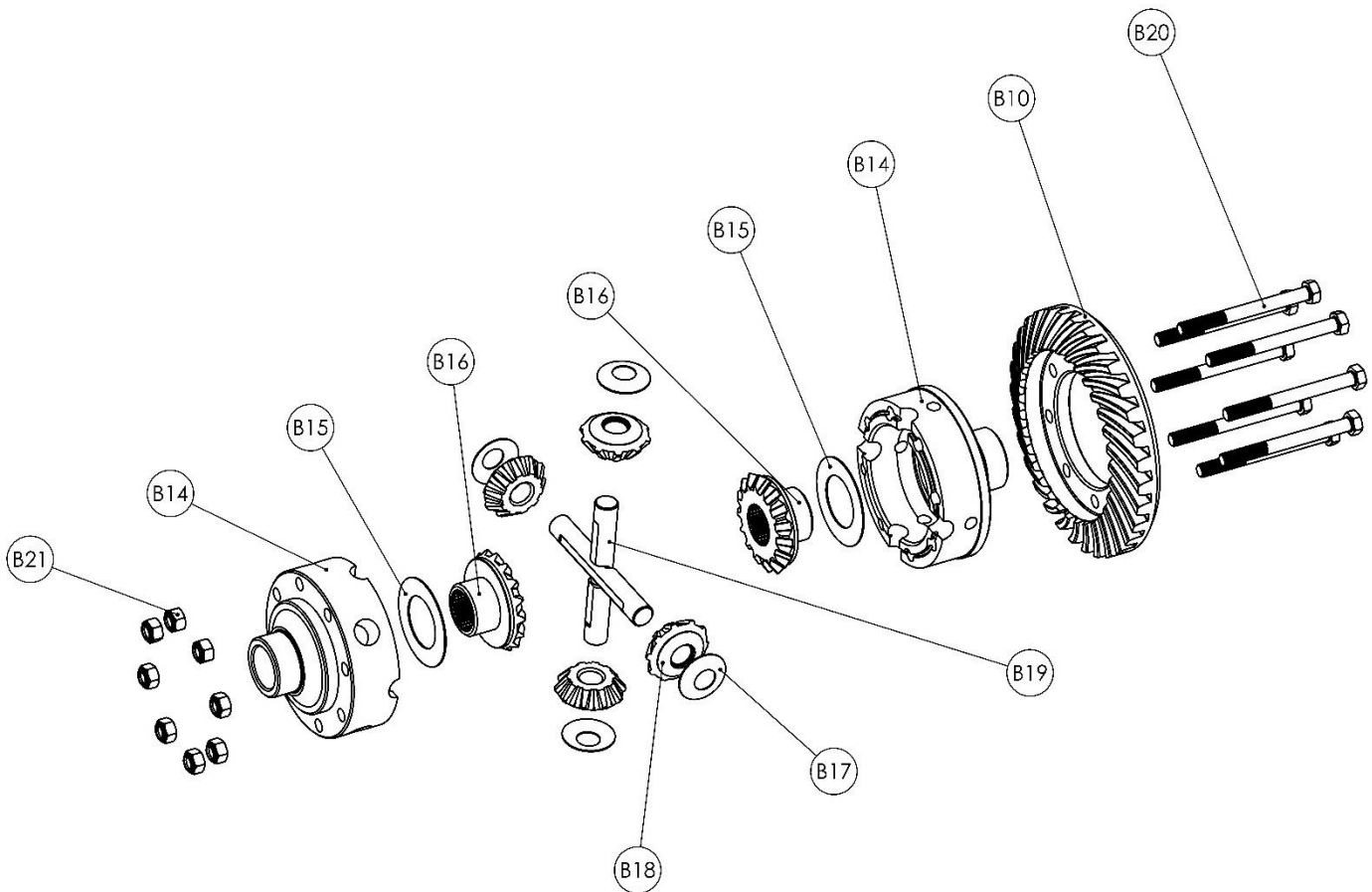

Section 'C' – Planet Carrier Assembly

Item	Part No	Qty	Description
C1	612-0250	3	Planet Pin
C2	915-0270	6	Washer Thrust
C3	0564502	6	Needle Roller Bearing
C4	612-2560	3	Spacer
C5	613-0080 612-0080	3	Planet Gear 612B13N012 Only 612B20N012 Only
C6	612-0060	1	Planet Carrier
C7	010-0030	3	Spring Pin
C8	400-1320	1	Spacer
C9	003-0120	1	Circlip
C10	0211620	1	Dowel
C11	613-0070 612-0070	1	Annulus 612B13N012 Only 612B20N012 Only
C12	613-0090 612-0090	1	Sun Gear 612B13N012 Only 612B20N012 Only

NOTE: Quantities stated per side (2 Assemblies per Axle)

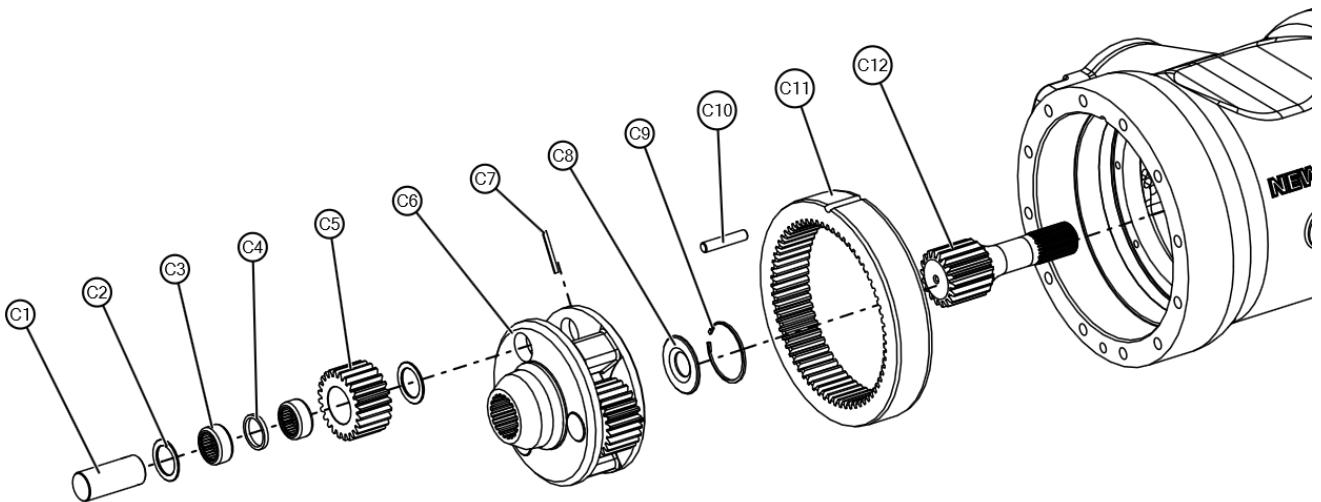

Section 'D' – Axle Arm, Hub and Brake Assemblies

Arm Assembly 8 Studs M20 x 1.5 on 10.83" PCD (275mm)			
Item	Part No	Qty	Description
D1	0081525P	8	Cap Screw M10 x 25mm
D3	010N801	1	Lock Nut
D4	010W801	1	Lock Washer
D5	615-1440	1	Spacer
D6	0540803	2	Taper Roller Bearing
D7	0431343V	1	Viton "O" Ring
D10	613-2850	1	Hub Seal
D11	612-2521-KIT	4	Service Brake Pad Set
D12	614-2501	2	Brake Caliper
D13	0191314	4	Lock Washer
D14	00816A40MZP	4	M14 x 40mm Cap Bolt
D15	0041614HTP	12	M16 x 55mm Bolt
D16	612-0028	1	Axle Arm Pad 23.625" Mounting 4Deg L/H
	612-0029		Axle Arm Pad 23.625" Mounting 4Deg R/H
D17	612-0050	1	Hub Adaptor
D18	0081845	8	Cap Head M20 x 45mm
D19	613-0040	1	Wheel Hub
D20	613-0450	8	M20 x 1.5 Wheel Studs
D21	613-0100	1	Axle Shaft
D22	007-0410	8	M20 x 1.5 Wheel Nut (NOT SHOWN)

NOTE: Quantities stated per side (2 Assemblies per Axle)

